

Bar stock needle valve designed for operation with any fluid.

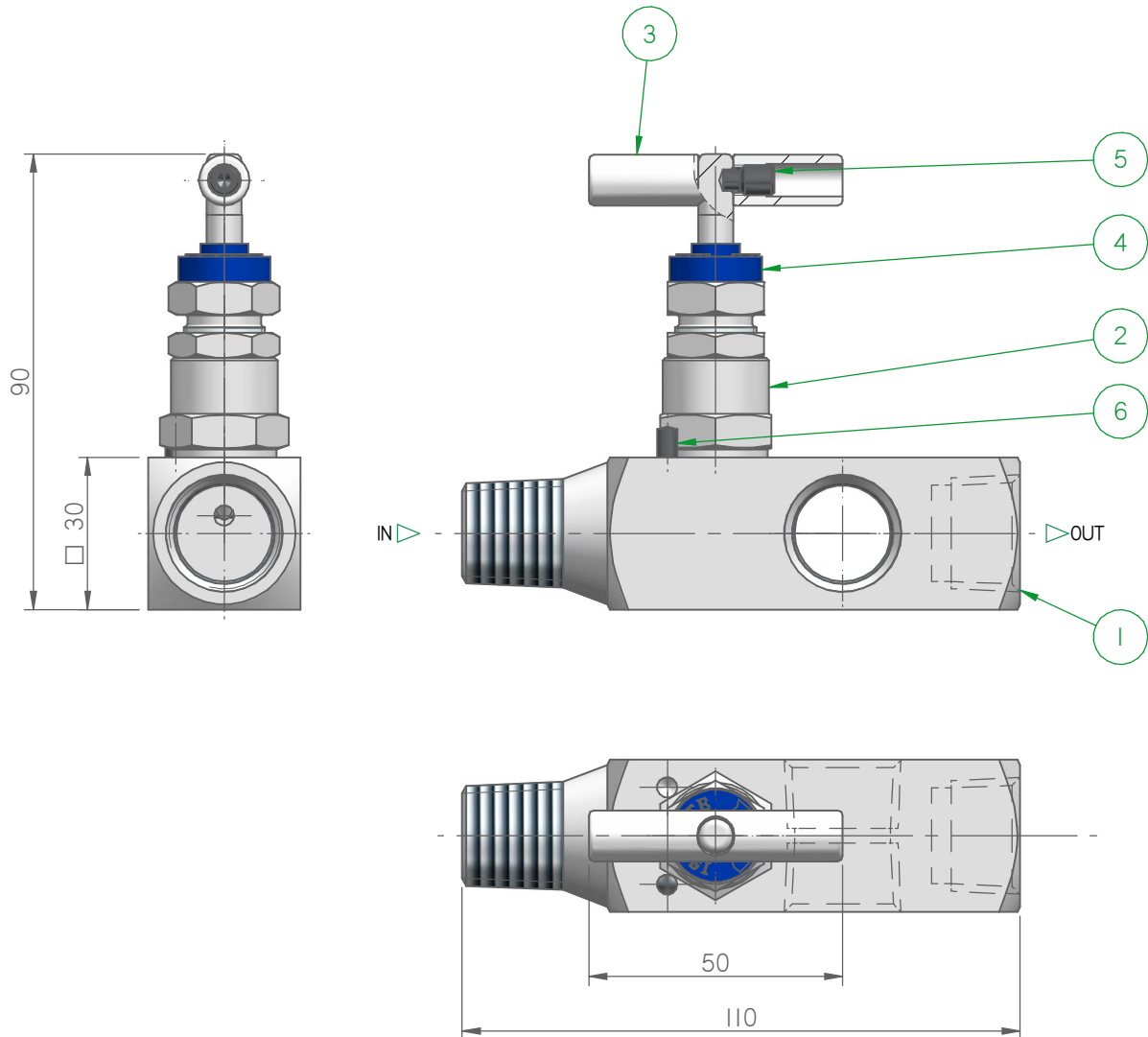

Example for a typical product. The dimensions shown in this datasheet apply to standard types. If you need the dimensions for your individual type or should you still not find your options at all please contact the factory.

### BILL OF MATERIALS

POS.	DESCRIPTION	MATERIAL	QTY
1	BODY VLV. MOD. V71 1/2" NPT	AISI 316L	1
2	BONNET 316L/PTFE	AISI 316L / PTFE	1
3	T HANDLE 50mm	AISI 303	1
4	DUST CUP	HYTREL BLU	1
5	NO HEAD SCREW M6x10 - 45H - DIN 915	A2	1
6	PIN 4X12 - ISO 8741	A2	1

### MODEL

MODEL	RATING	MATERIAL	PACKING	IN	OUT	INSIDE DIAMETER	NOTE
V71	3/6/10K psi	AISI 316L*	PTFE*	1/2" NPT*	1/2" NPT*	4mm/0,15in*	*for more options see next sheet

The dimensions shown apply only to the illustrated valve – if you need the dimensions for your individual type or should you still not find your options at all please contact the factory.

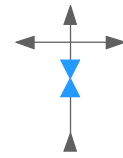

Bar stock needle valve designed for operation with any fluid.

### STANDARD FEATURES

PTFE and GRAPHOIL packing available for all valve types.

Wetted parts according to **NACE MR.0175/MR.0103** as standard.

Shell test and seat leakage test are performed according to **API 598** and **ASME B16.34** (1.5 of max rating pressure).

**Certificate 3.1** certificate according to EN 10 204 on valve body material.

Valves and manifold are not supplied with plugs unless specified

### SPECIAL FEATURES

O-Ring packing

**Oxygen service** PTFE packing cleaned and degreased

### MATERIAL

MATERIAL GROUP	I.T.E. DESIGNATION	ASTM	UNS
Stainless Steel	316/316L	316/316L	S31600
	6Mo		N08367
Ferritic Stainless Steel	Duplex	F51	S31803
	Superduplex	F55	S32750
Carbon Steel	LF2	LF2	
	A105	A105	
Alloy	Alloy 400		N04400
	Alloy C276		N10276
	Alloy 625		N06625
	Alloy 825		N08825
Titanium	Ti Gr.2		R50400

### CONNECTIONS

NPT threads acc. to. ASME B 1.20.1  
 BSPT threads acc. to. ISO 7/1  
 BSPP threads acc. to. ISO 228-1/ISO 1179-1  
 Metric threads acc. to. ISO 261  
 G Threads acc. to. ISO 228-1/EN 837-1  
 Butt weld (male) acc. to. ASME B16.9  
 Socket Weld (female) acc. to. ASME B16.11

### BONNET FEATURES

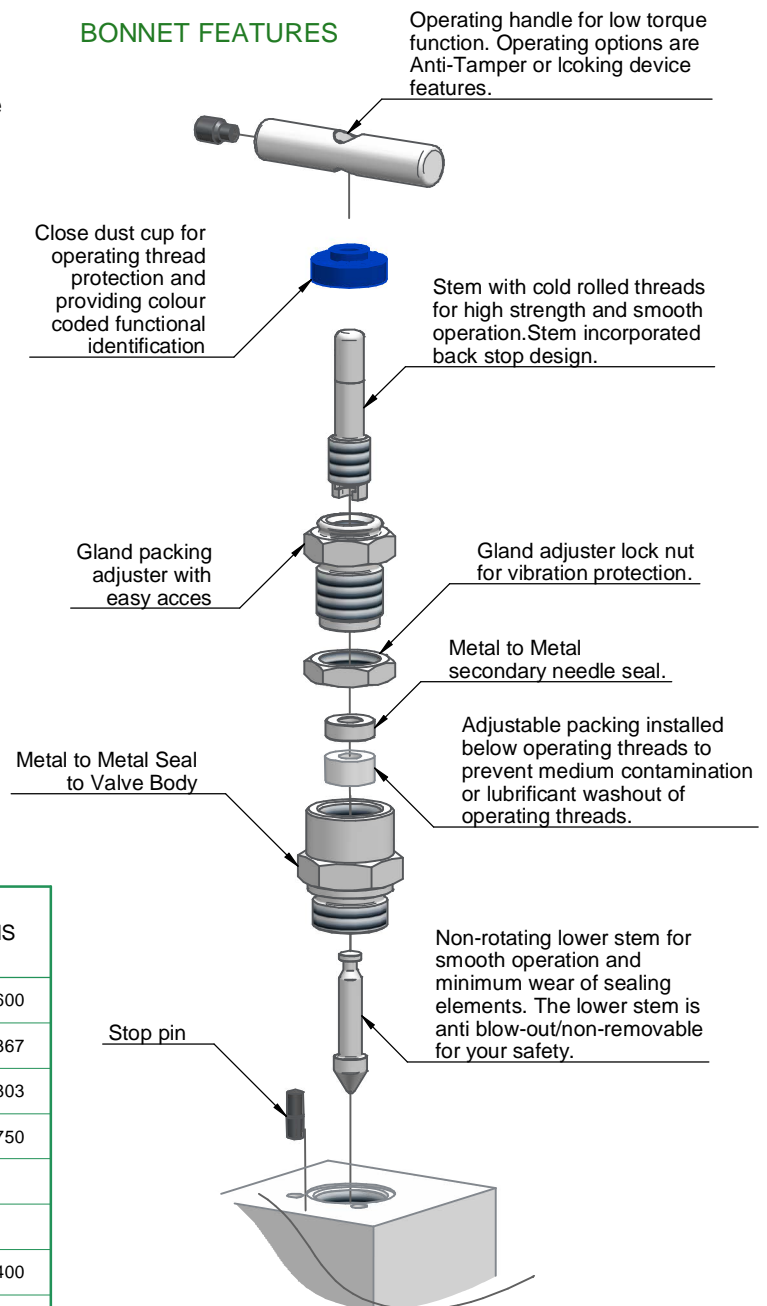

- Maximum standard pressure up to 6.000 psig (414 barg).
- Maximum optional pressure up to 10.000 psig (689 barg).
- Temperature range -54°C to +530°C.
- PTFE standard gland packing (Graphoil optional).
- Max. temperature PTFE 260°C.
- Max. temperature Graphoil 530°C.
- Low operating torque.
- Packing below threads to prevent lubricant washout.