

CV-8600/U & CV-8600/S

Wide range of materials available, in accordance with Licensor specification

As an option, to avoid fluid crystallization, a built-in circuit for a homogeneous body heating, without external welded jacketing, is available.

Swing through or eccentric disc design is available according to required sealing class and differential pressure

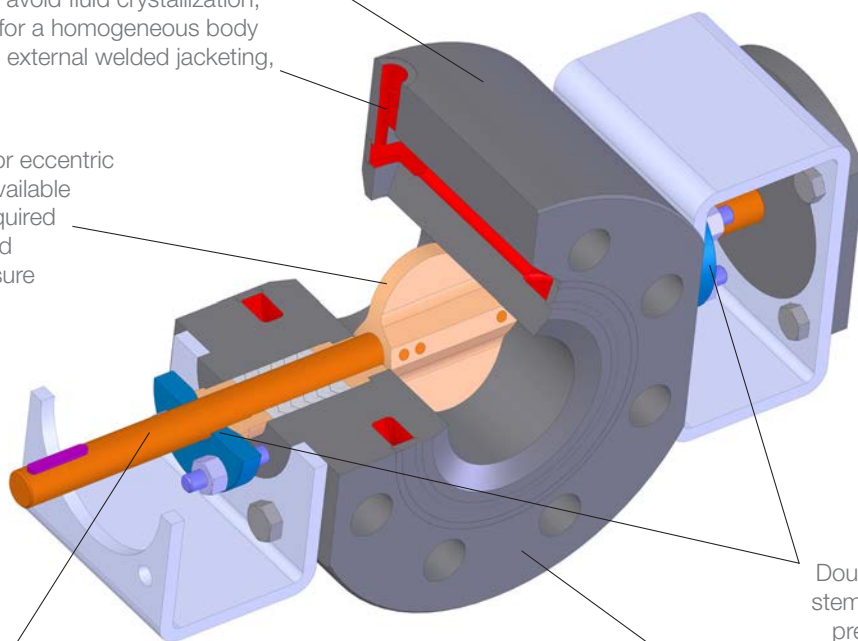

One piece single diameter shaft gives great rigidity with minimal deflection

Double packing execution for stem thrust balancing on high pressure service is available

Connections can be machined in accordance with Licensor standard

Main features

This valve series is designed and manufactured to resist to aggressive and corrosive fluids, as per Urea plant application. Although these valves have been designed for high pressures, they are also available for low pressure with special materials.

The valve body is generally from casting for pressures class 150 to 600, whereas for high pressure class and Urea application it is supplied in forged block only. Valve body can be jacketed type and heated by steam or diathermic fluids.

Materials: ASTM A182 F316L, F316L urea Grade, F310 MoLn S31050. Other material, in accordance to the Licensor standard, are available.

Connections: Flange, studded, lugged or wafer style connections, together with connection in accordance with Licensor standard, are available.

Sizes / Pressure Classes

Size: NPS 4 to NPS 12.

Rating: up to ASME 2500 or PN 400.

Design Codes & Product Standards

IEC 60534, FCI 70-2, EN12516, EN 1092, ASME B16.34, ASME B16.5.